

横版彩色



横竖比例5:3 (可按实际器材大小调整具体尺寸)

竖版彩色



横竖比例3:4 (可按实际器材大小调整具体尺寸)

建议材质：不锈钢或铝型材烤漆

颜色色值：

C0 M0 Y0 K100

C0 M28 Y100 K0

C0 M100 Y100 K0

C100 M30 Y0 K0

C100 M0 Y100 K0

C0 M0 Y100 K0

生产商标牌位置示意

与横版体彩标牌组合

生产商信息标牌与体彩标牌比例为1:2 (可按实际器材大小调整具体尺寸)



与横版体彩标牌组合

生产商信息标牌与体彩标牌比例为1:4 (可按实际器材大小调整具体尺寸)



生产商信息牌的颜色可根据制作材料作具体调整

◆ 体育彩票公益金资助项目标牌设计及安装规范

生产商信息标牌与竖版体彩标牌组合应用

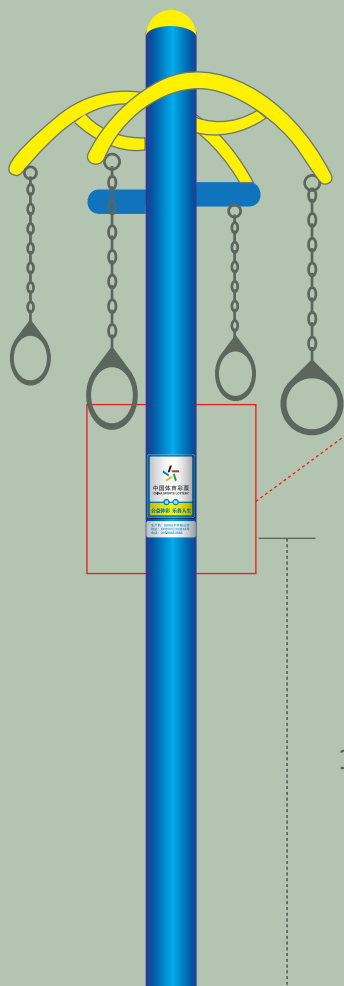
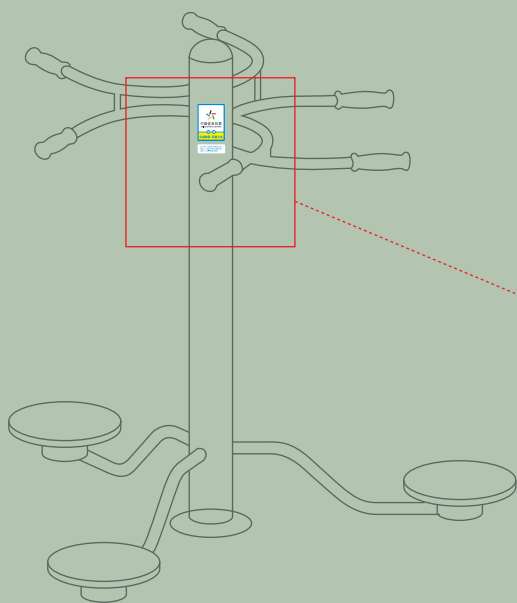

120mm (标牌距离地面高度, 可根据器材的高度调整)

◆ 体育彩票公益金资助项目标牌设计及安装规范

生产商信息标牌与横版体彩标牌组合应用

标牌在横版应用时，左右居中即可。

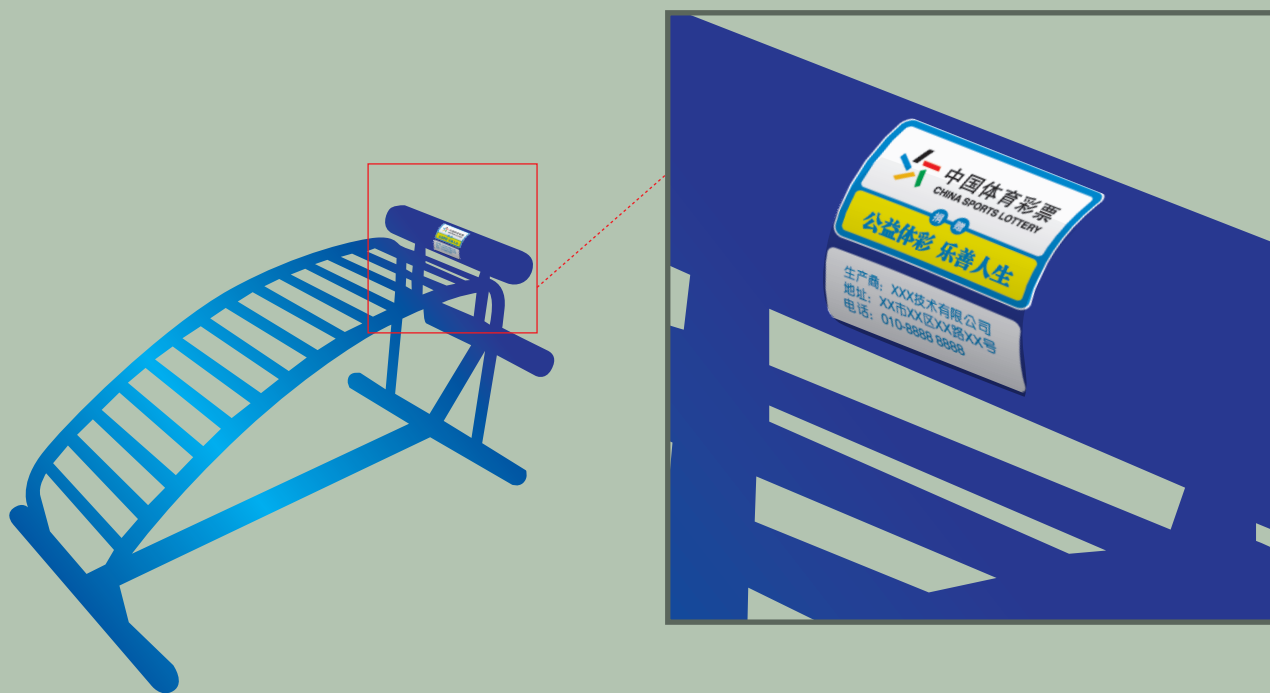

捐赠牌应用



全民健身中心和场馆的牌匾应用

牌匾（建议材质：不锈钢烤漆）

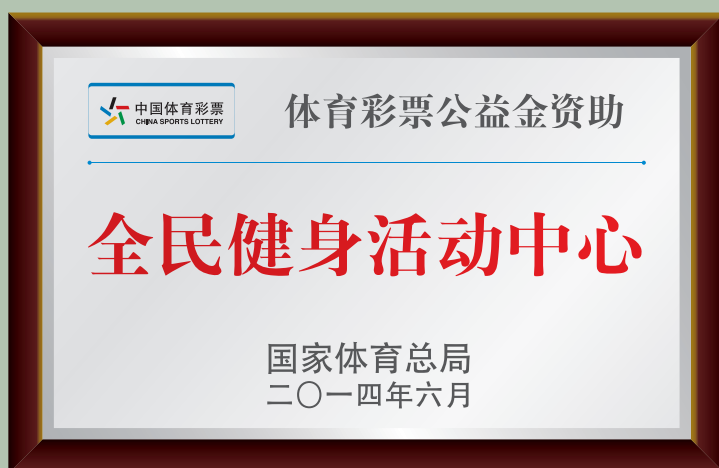

立式牌（建议材质：不锈钢、大理石雕刻）

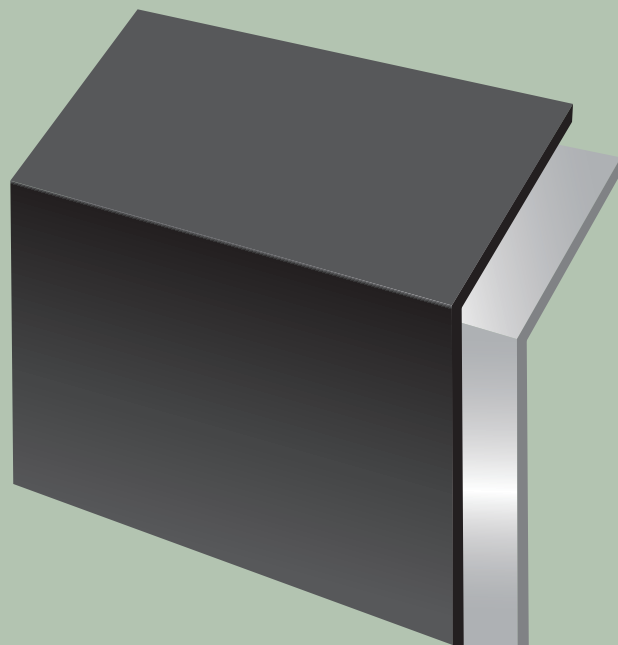

牌匾应用（建议材质：不锈钢烤漆）



项目名称即公益金资助项目名称。资助项目包括体育彩票公益金资助或作为引导资金开展的群众体育项目（含全民健身场地设施、体育健身器材、全民健身活动等）、青少年体育项目、竞技体育项目以及其他体育事业相关工作项目。具体请参考《体育彩票公益金资助项目宣传管理办法》第九至十三条和附件一《体育彩票公益金资助项目目录》。

牌匾应用（建议材质：不锈钢烤漆）

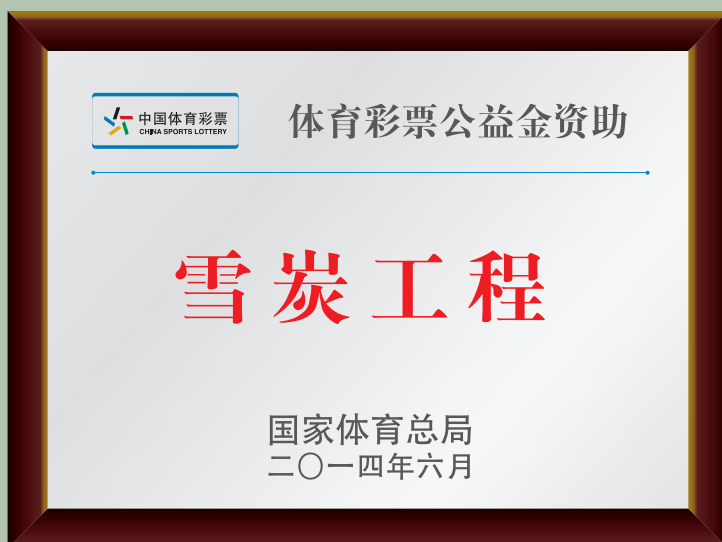
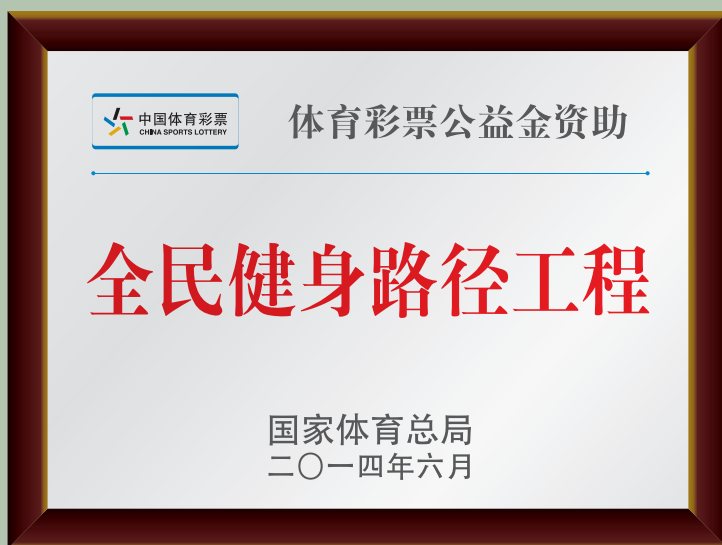
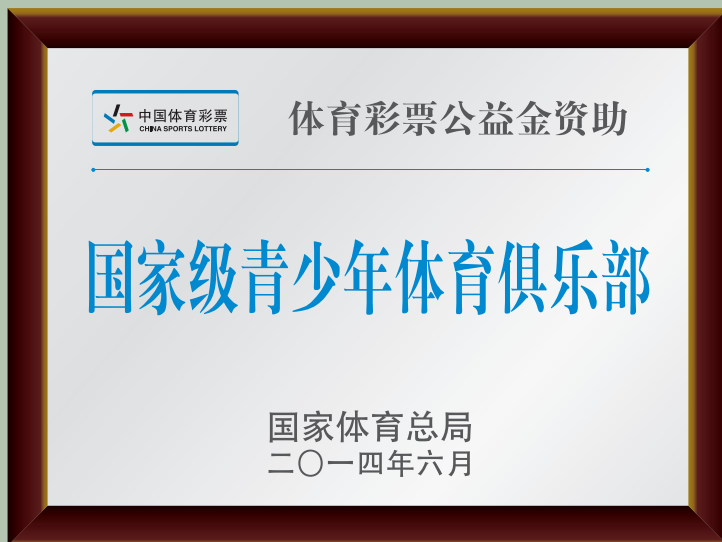

室内乒乓球场应用效果图



设计文件



体育场馆外立面应用效果图



设计文件



赛场赛道应用效果图



设计文件



◆ 体育彩票公益金资助项目标牌设计及安装规范

室内篮球场应用效果图



设计文件



◆ 体育彩票公益金资助项目标牌设计及安装规范

室外路旗应用效果图



设计文件

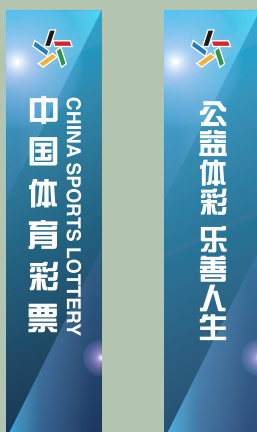

◆ 体育彩票公益金资助项目目标牌设计及安装规范

室外网球场应用效果图



设计文件

